

Point marking

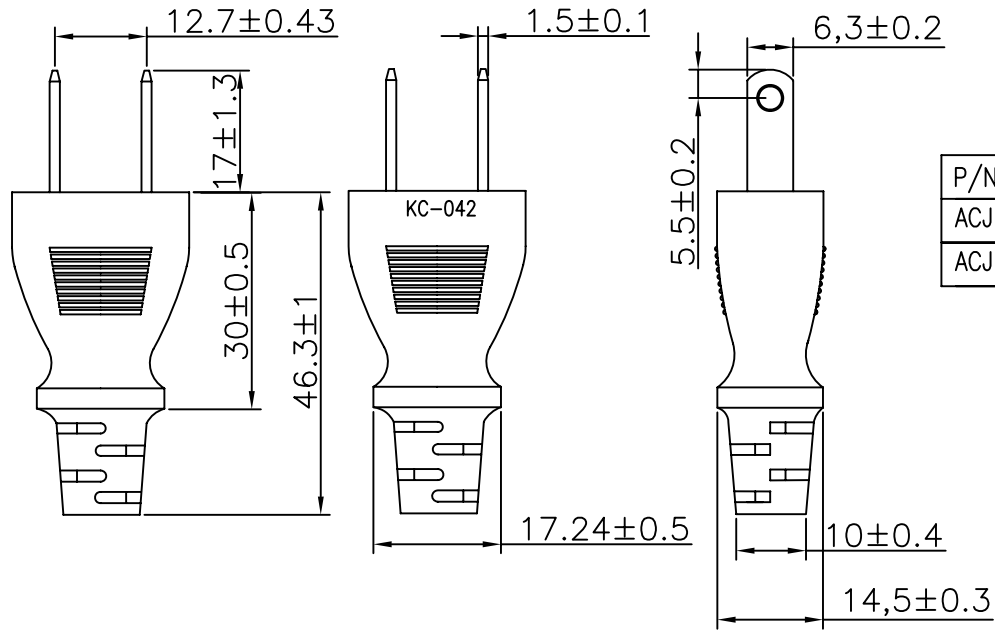

P/N	L(MM)	TOLERANCE(MM)	N(MM)
ACJ-2P-WOG-02	2000	±50	200±30
ACJ-2P-WOG-03	3000	±50	250±30

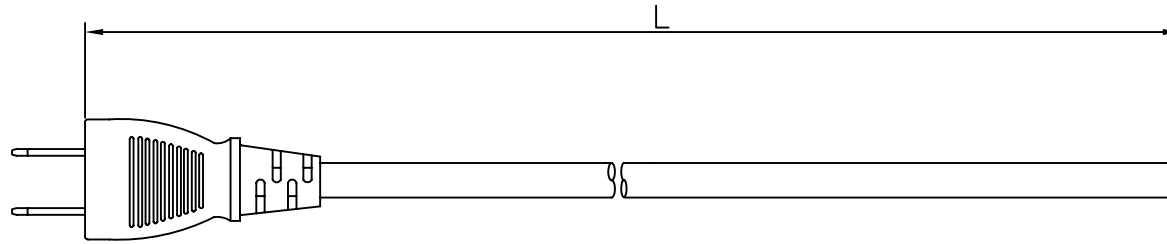
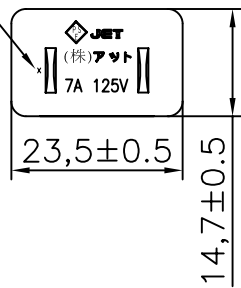
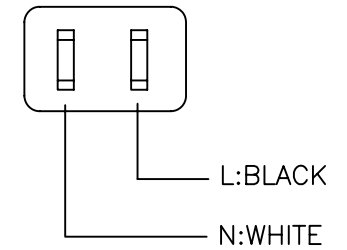

- 1.CABLE:VCTFK 2*0.75mm² JACKET BLACK OD=φ4.3*6.6±0.1mm
- 2.PVC:88 A PVC BLACK
- 3.COLOR:BLACK
- 4.Tie:BLACK

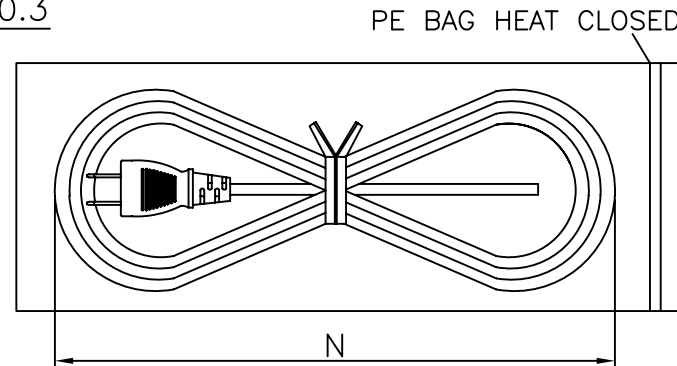

KC-042: JET

NET MECHANISM Corp				
www.cabling-ol.net				
SCALE	NONE		REV	A
UNIT	MM			
SHEET	1/1	DWG NO.K42001V4XXXBR		
DATE	09/03/05			
TITLE				
PART NO.				