

Point marking

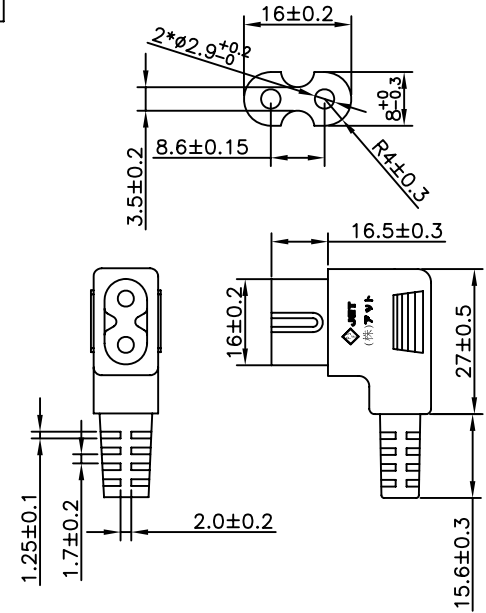

P/N	L(MM)	TOLERANCE(MM)	N(MM)
ACJ-2P2LS-WOG-02	2000	±50	200±30
ACJ-2P2LS-WOG-03	3000	±50	250±30

- 1.CABLE:VCTFK 2*0.75mm² JACKET BLACK OD=∅4.3*6.6±0.1mm
- 2.PVC:88 A PVC BLACK
- 3.COLOR:BLACK
- 4.Tie:BLACK

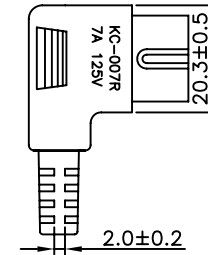
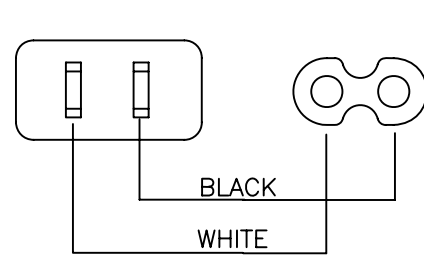
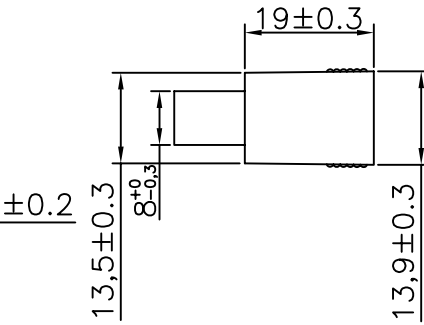
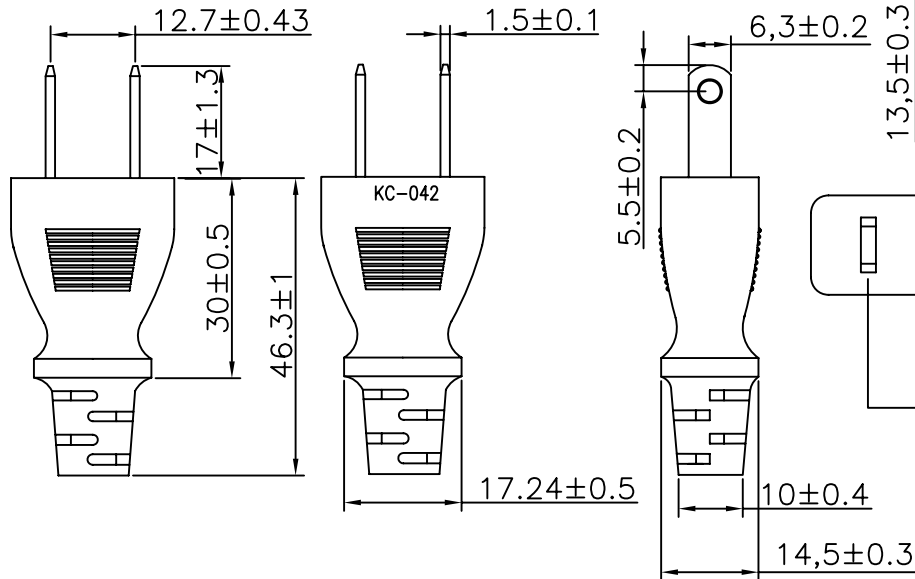
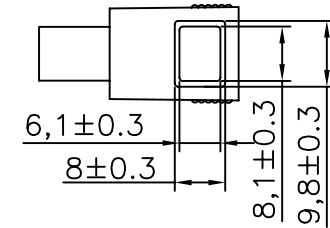
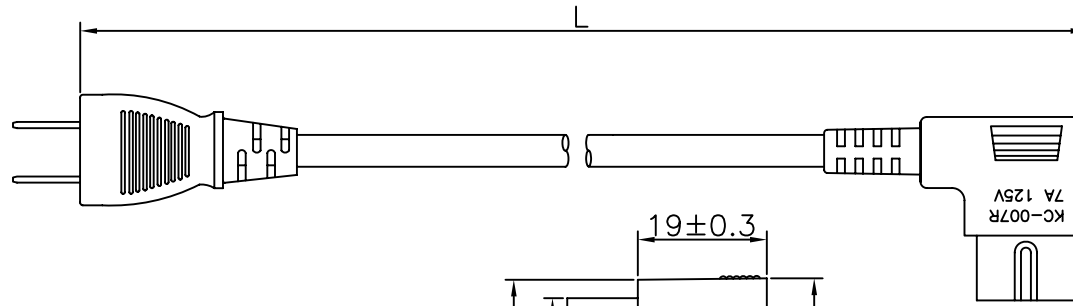
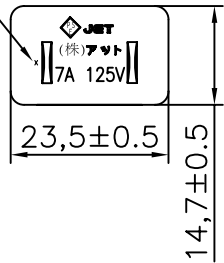
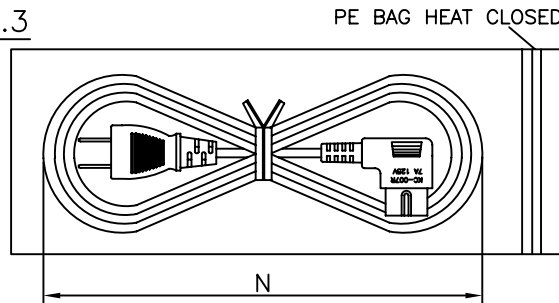

KC-042: JET

KC-007R: JET

NET MECHANISM Corp www.cabling-ol.net				
SCALE	NONE		REV	A
UNIT	MM			
SHEET	1/1	DWG NO.K427R1V4XXXBR		
DATE	09/03/05			
TITLE				
PART NO.				