

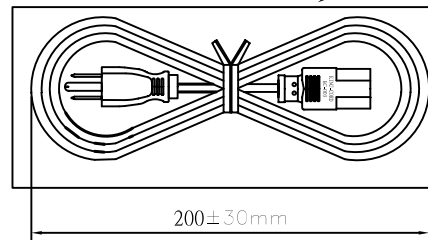

PE BAG HEAT CLOSED



KC-001 →  JET

KC-003 →  JET

- 1.CABLE:VCTF 3*2.0mm² JACKET BLACK OD=ø8.5±0.15mm
- 2.PVC:88 A PVC BLACK
3. COLOR:BLACK
- 4.Tie:BLACK

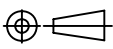
NET MECHANISM Corp www.cabling-ol.net				
SCALE	NONE		REV	C
UNIT	MM			
SHEET	1/1	DWG NO.KJ1J31TB200BR		
DATE	08/04/14			
TITLE				
PART NO.		ACJ-3PS-15A-02		