





KC-001 →  JET

KC-003 →  JET

1. CABLE: VCTF 3*0.75mm² JACKET BLACK OD=∅7.0±0.1mm
2. PVC: 88 A PVC BLACK
3. COLOR: BLACK
4. Tie: BLACK

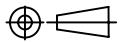
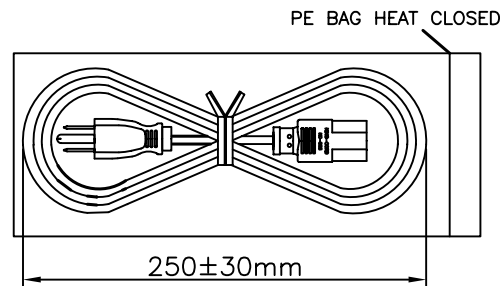
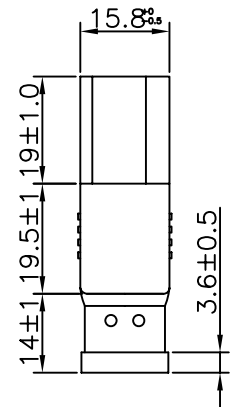
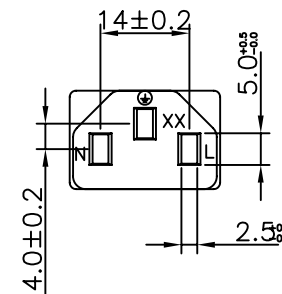
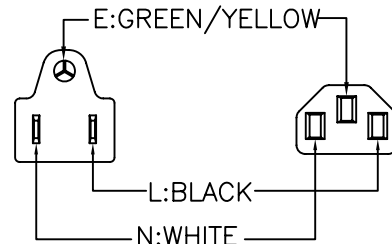
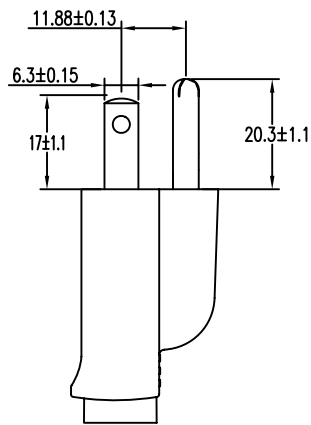
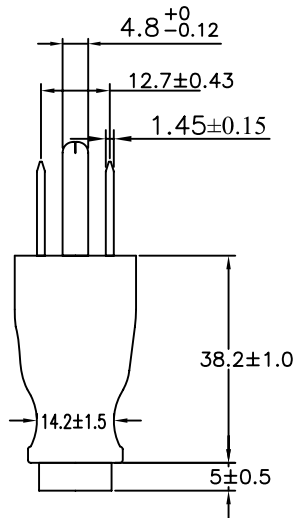
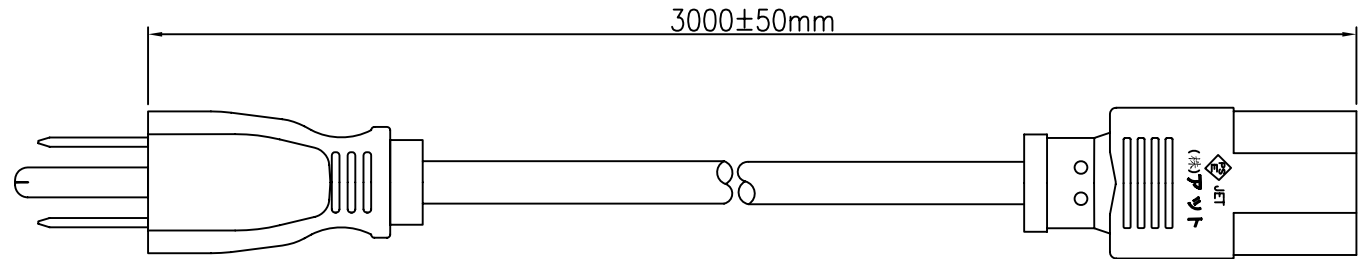
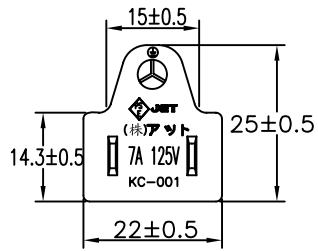
NET MECHANISM Corp www.cabling-ol.net				
SCALE	NONE		REV	B
UNIT	MM			
SHEET	1/1	DWG NO. KJ1J31T3200BR		
DATE	08/04/11			
TITLE				
PART NO.		ACJ-3PS-02		



KC-001 →  JET

KC-003 →  JET

1. CABLE: VCTF 3*0.75mm² JACKET BLACK OD=∅7.0±0.1mm
2. PVC: 88 A PVC BLACK
3. COLOR: BLACK
4. Tie: BLACK

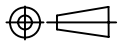
NET MECHANISM Corp www.cabling-ol.net				
SCALE	NONE		REV	B
UNIT	MM			
SHEET	1/1	DWG NO. KJ1J31T3300BR		
DATE	08/04/11			
TITLE				
PART NO.		ACJ-3PS-03		

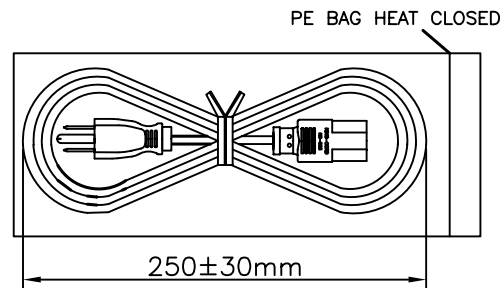
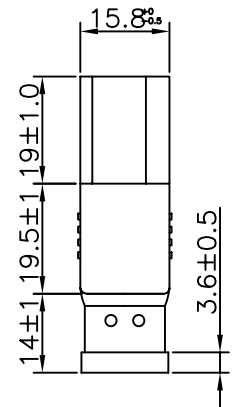
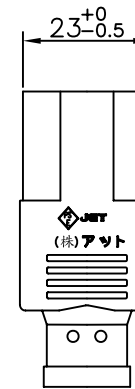
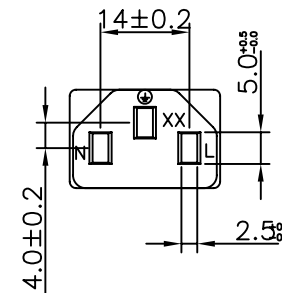
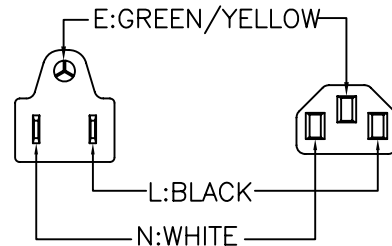
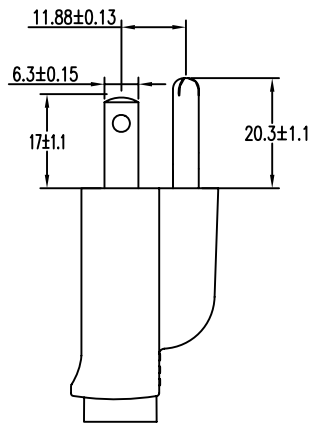
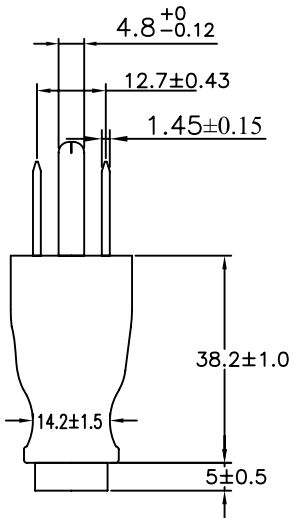
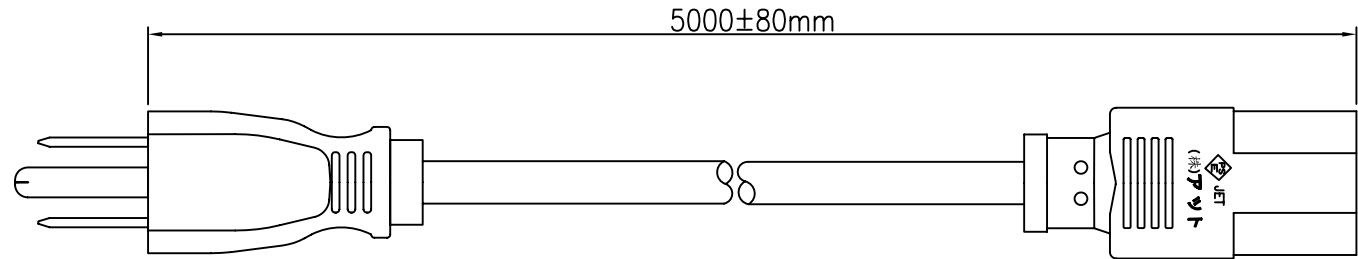
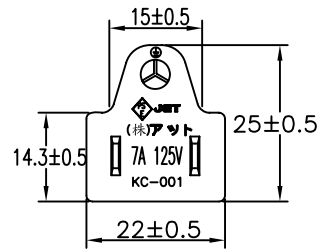

KC-001 → JET

KC-003 → JET

1. CABLE: VCTF 3*0.75mm² JACKET BLACK OD=∅7.0±0.1mm
2. PVC: 88 A PVC BLACK
3. COLOR: BLACK
4. Tie: BLACK

NET MECHANISM Corp www.cabling-ol.net				
SCALE	NONE		REV	B
UNIT	MM			
SHEET	1/1	DWG NO. KJ1J31T3500BR		
DATE	08/04/11			
TITLE				
PART NO.		ACJ-3PS-05		