

SECTION B-B

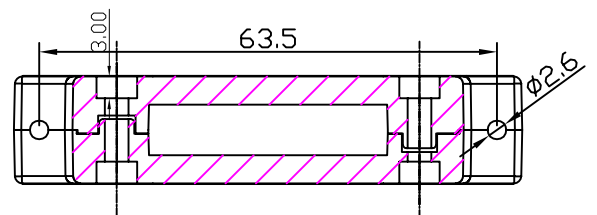

SECTION A-A

NET MECHANISM Corp www.cabling-ol.net				
SCALE	NONE		REV	A
UNIT	MM			
SHEET	1/1	DWG NO.		
DATE	07/01/08			
TITLE				
DB37P HOOD				
PART NO.				
HOOD-DB37P-440				

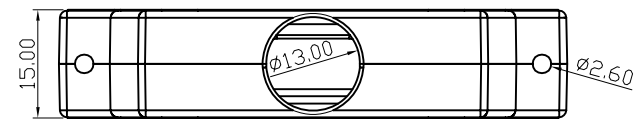
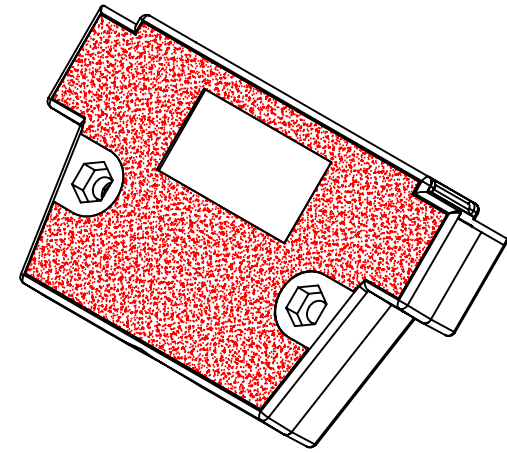
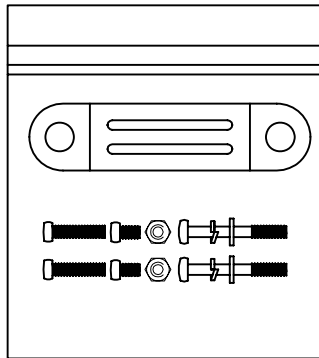
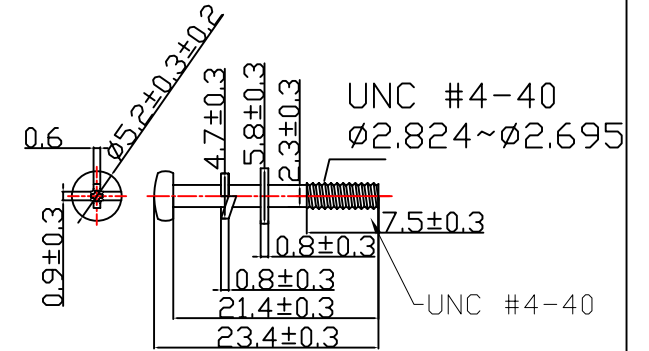
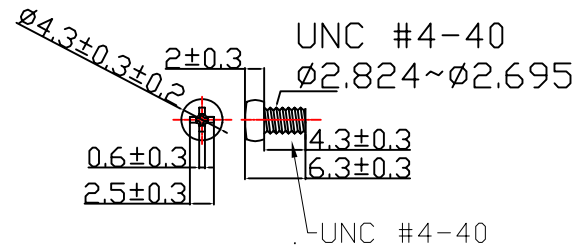
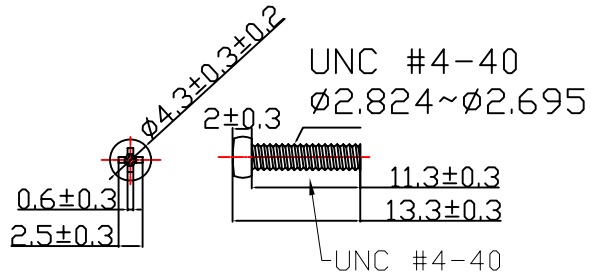
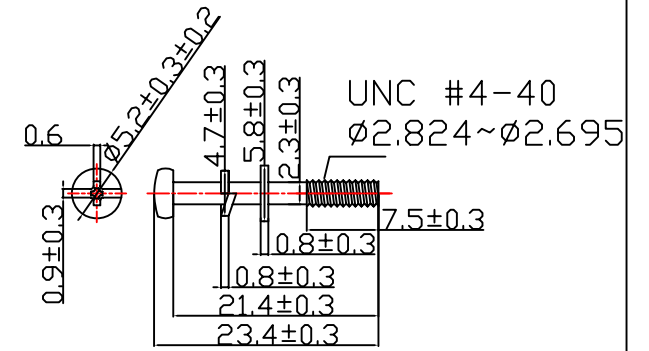
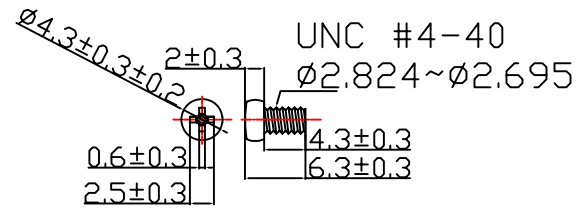
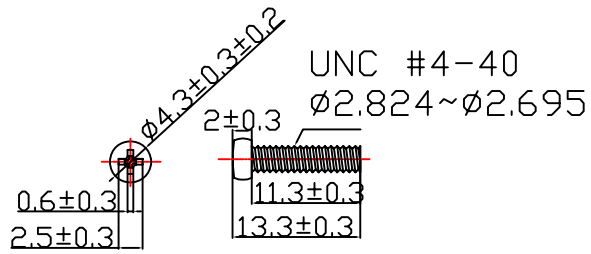

T-ZP-2-3-6C

PACKING: EACH SET IN A POLY-BAG

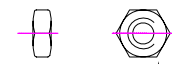
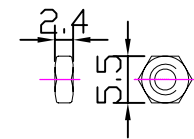
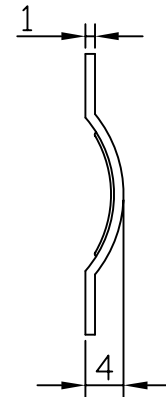
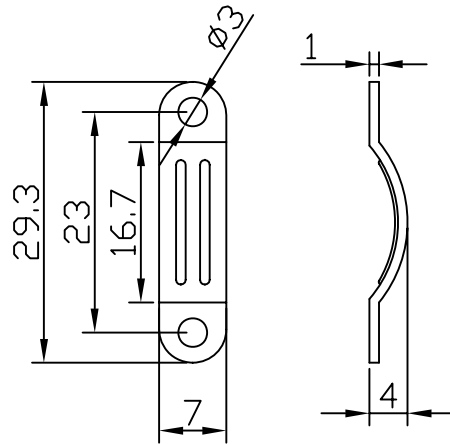

UNC #4-40

NET MECHANISM Corp www.cabling-ol.net				
SCALE	NONE		REV	A
UNIT	MM			
SHEET	1/1	DWG NO.		
DATE	07/01/08			
TITLE DB37P HOOD				
PART NO. HOOD-DB37P-440				