

RevNo	Revision note	Rev-By	RevDate	Signature	Checked

COMPOSITE VIDEO CABLE TYPE MODULE

ITEM NO: FU-RCA-200

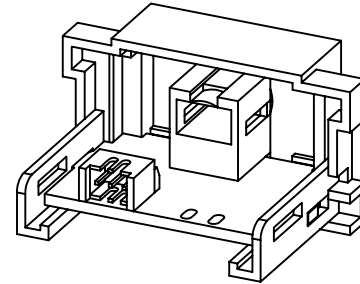
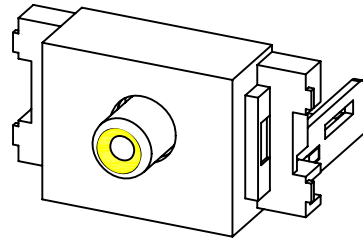
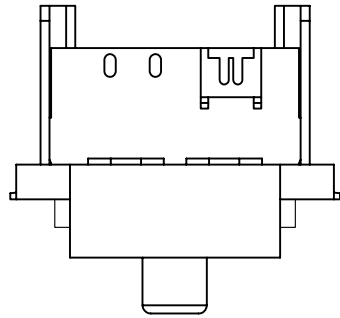

2015-10-30
Update

Before 30.8mm
Modify to 31.8mm

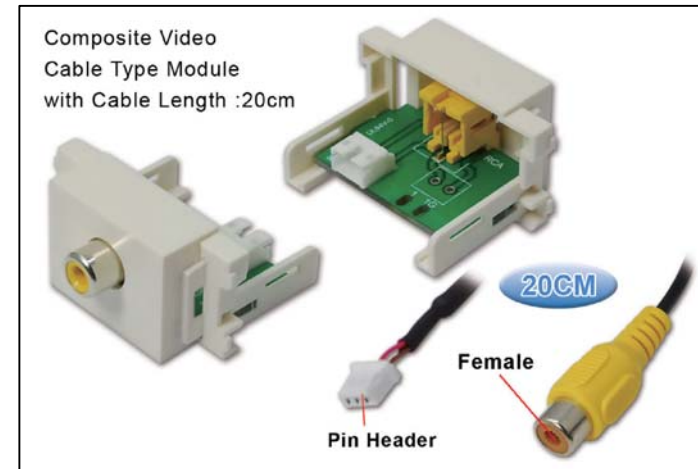
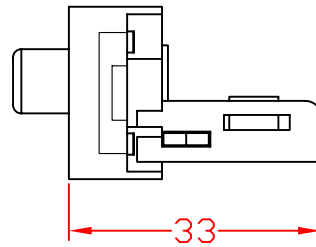
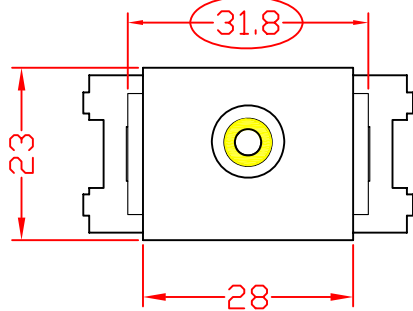

FEATURES:

- Composite Video Cable Type Module
- with 20cm Pin Head to Video RCA Cable
- Material : ABS
- Color : RAL9010
- Size: 28 x 23 x 33mm

ITEM NO.	FU-RCA-200			
PART NO.				
DESIGNED BY ALEX	DATE	151030	UNIT	MM
	SCALE	1:1	VER.	1
NO.	Checked by			
APPR:	Approved by -date			

RevNo	Revision note	Rev-By	RevDate	Signature	Checked

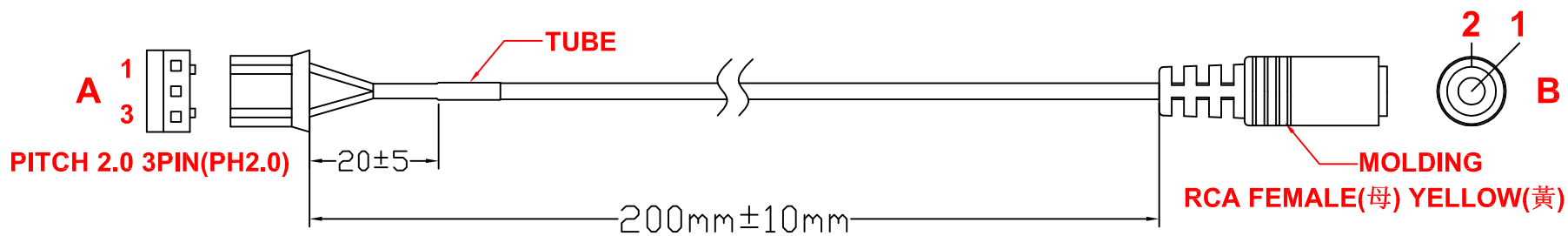

A ————— **B**
1 ————— **1**
3 — **GND** — **2**

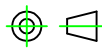
ITEM NO.	FU-RCA-200			
PART NO.				
DESIGNED BY Young	DATE	131025	UNIT	MM
	SCALE	1:1	VER.	1
NO.		Checked by		
APPR:		Approved by -date		