

Frontplattenausschnitt (Rückseite)  
panel cut out (rear side)

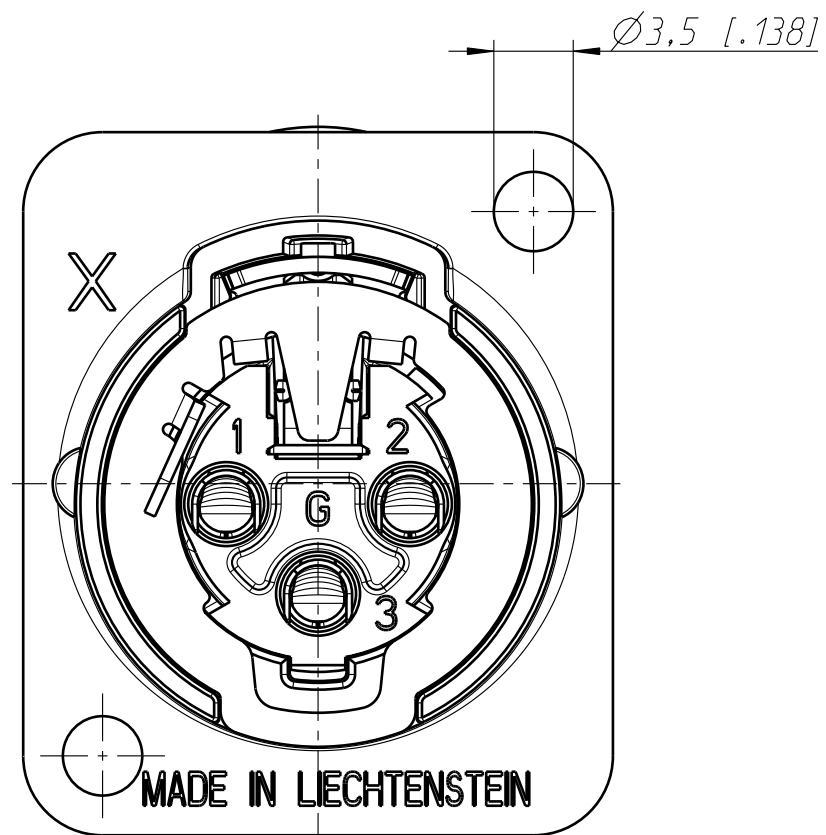
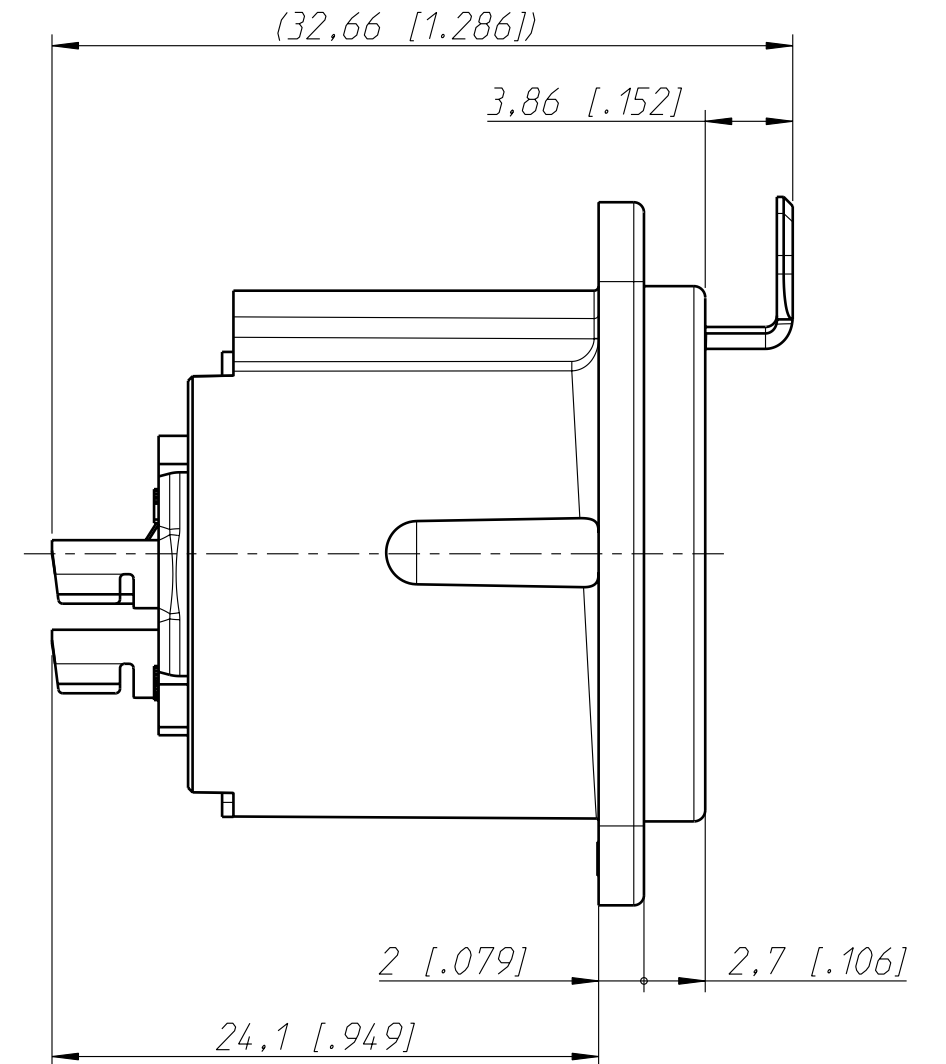
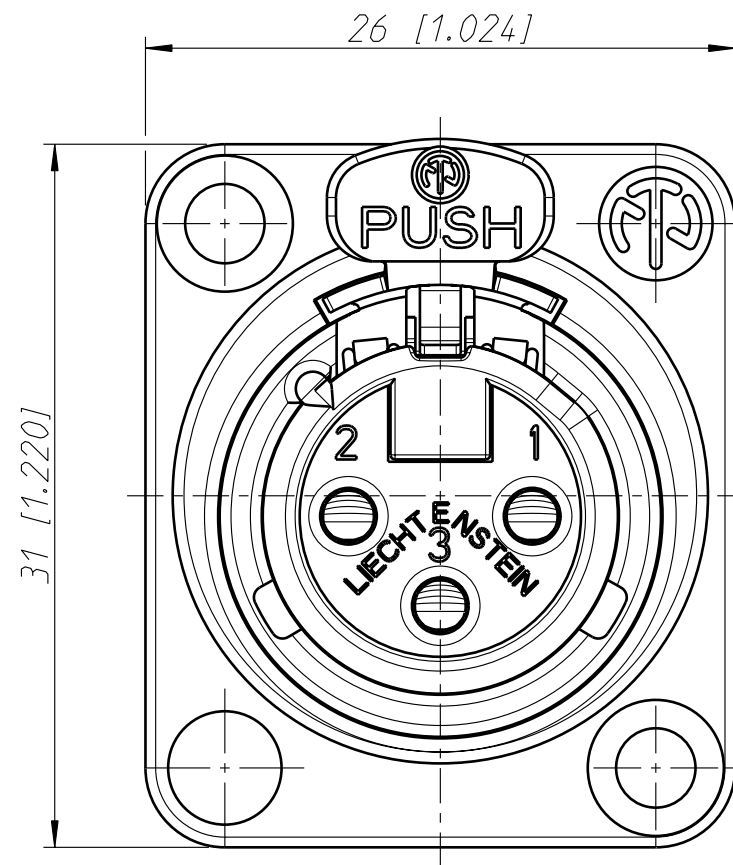
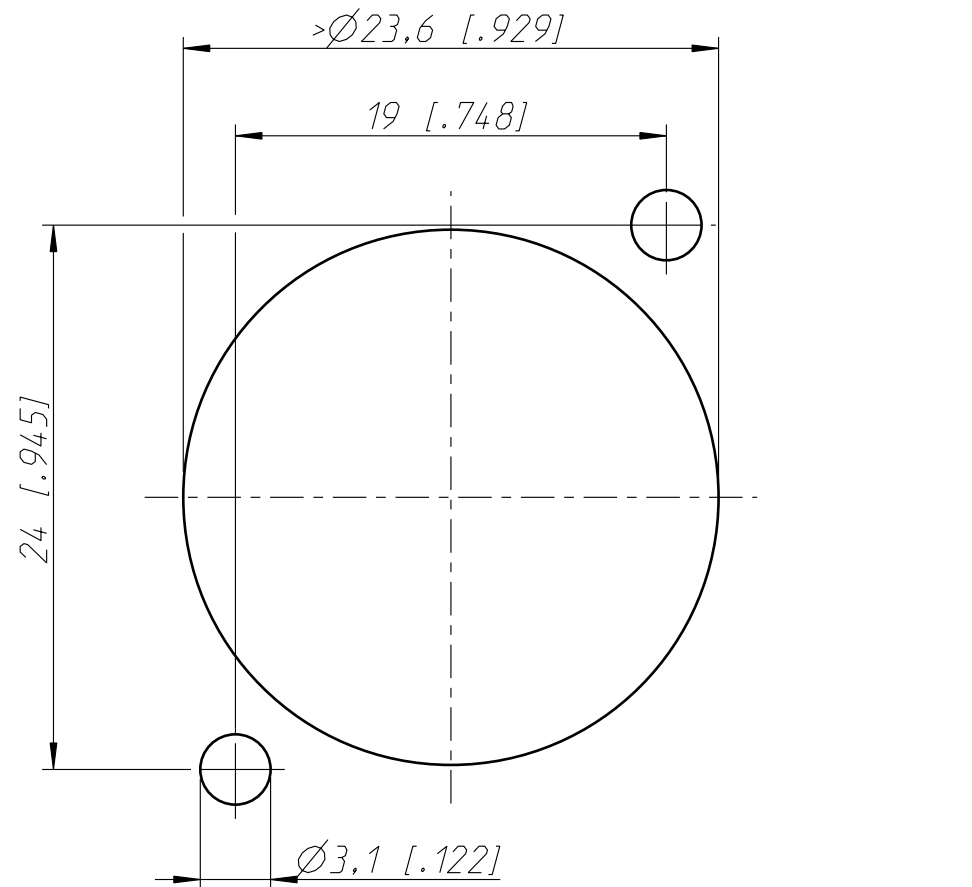

Allgemeintoleranzen ISO 2768-m	Werkstoff	Massstab:	Datum	Name	
Zeichnung urheberrechtlich geschuetzt (DIN 34) (C)	KEIN_MAT -	3:1 (A3)	Gezeichnet	19.06.06	Ender
			Freigegeben	-	-
			Geaendert	-	-
Benennung		NC3FD-LX NC3FD-LX	Aend.-Nr. -	Aend.-Index Blatt 1 von 1 Bl.	
NEUTRIK AG FL-9494 SCHAAN			Zeichn. Nr.	ST-NC3FD-LX	